

绍兴凯一同步带有限公司

Shaoxing CSHBELT Co., Ltd.

POLYURETHANE TIMING BELTS

聚 氨 酯 同 步 带

SPECIAL TIMING BELTS

特 殊 同 步 带

(目录) Directory

公司概况 Company Profile	... 03
-------------------------	--------

聚氨酯同步带 Polyurethane Timing Belts	... 05
-------------------------------------	--------

T2.5 Open Ended Specification	... 07	HTD14M Open Ended Specification	... 22
T5 Open Ended Specification	... 08	S2M Open Ended Specification	... 23
T10 Open Ended Specification	... 09	S3M Open Ended Specification	... 24
T20 Open Ended Specification	... 10	S5M Open Ended Specification	... 25
AT5 Open Ended Specification	... 11	S8M Open Ended Specification	... 26
AT10 Open Ended Specification	... 12	S14M Open Ended Specification	... 27
AT20 Open Ended Specification	... 13	RPP5M Open Ended Specification	... 28
MXL Open Ended Specification	... 14	RPP8M Open Ended Specification	... 29
XL Open Ended Specification	... 15	RPP14M Open Ended Specification	... 30
L Open Ended Specification	... 16	P1 Open Ended Specification	... 31
H Open Ended Specification	... 17	P2 Open Ended Specification	... 32
XH Open Ended Specification	... 18	P3 Open Ended Specification	... 33
HTD3M Open Ended Specification	... 19	P4 Open Ended Specification	... 34
HTD5M Open Ended Specification	... 20		
HTD8M Open Ended Specification	... 21		

TT5齿型同步带 TT5 Timing Belts	... 35
------------------------------	--------

CSHFLEX聚氨酯无接缝同步带 CSHFLEX Polyurethane Timing Belts	... 37
---	--------

特殊同步带 Special Timing Belts	... 39
-------------------------------	--------



CSHBELT

公司概况 Company Profile

公司简介

- 绍兴凯一同步带有限公司成立于2007年，全心致力于研发和生产工业用橡胶同步带、聚氨酯同步带。最新的技术、独特的制造工艺、先进的测控设备和专业的生产管理团队是产品品质的可靠保证。
- 绍兴凯一同步带有限公司提供的同步带产品广泛应用于工业传动系统，包括动力传动、直线运动、同步输送等等。

公司规模

- 投资额: 220万美元
- 年销售额: 超过500万美元
- 员工数量: 超过100人
- 厂区面积: 72000平方英尺
- 主要设备: 超过70台

我们的使命

- 绍兴凯一同步带有限公司的目标是：创新进取，为工业应用领域提供优质的橡胶同步带及聚氨酯同步带产品。

研发部门

- 最新的技术
- 独特的制造工艺
- 先进的测控设备
- 专业的生产管理团队
- 所有模具均自行设计制造

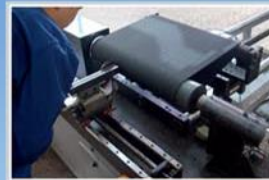

The company

- Shaoxing CSHBELT Co., Ltd. was founded in 2007. CSHBELT is a leading manufacturer of rubber timing belts and polyurethane timing belts for industrial applications. The newest technology, the unique fabrication technology, the advanced testing equipment and the specialized production management team are reliable guarantees of the products quality.
- CSHBELT products are widely applies in the industrial transmission system, including power transmission, linear motion, conveying and so on.

Our Mission

- CSHBELT mission is: Constantly innovation to provide the high quality rubber timing belts and polyurethane timing belts for all the industrial applications.

Company Size

- Investment value: 2.2 million USD
- Turnover: more than 5 million USD
- Employee: more than 100
- Factory area: 72000 square ft
- Main equipments: more than 70 units

R&D

- The newest technology
- The unique fabrication technology
- The advanced testing equipment
- The specialized production management team
- All molds are the independent design manufacture



聚氨酯同步带

Polyurethane Timing Belts

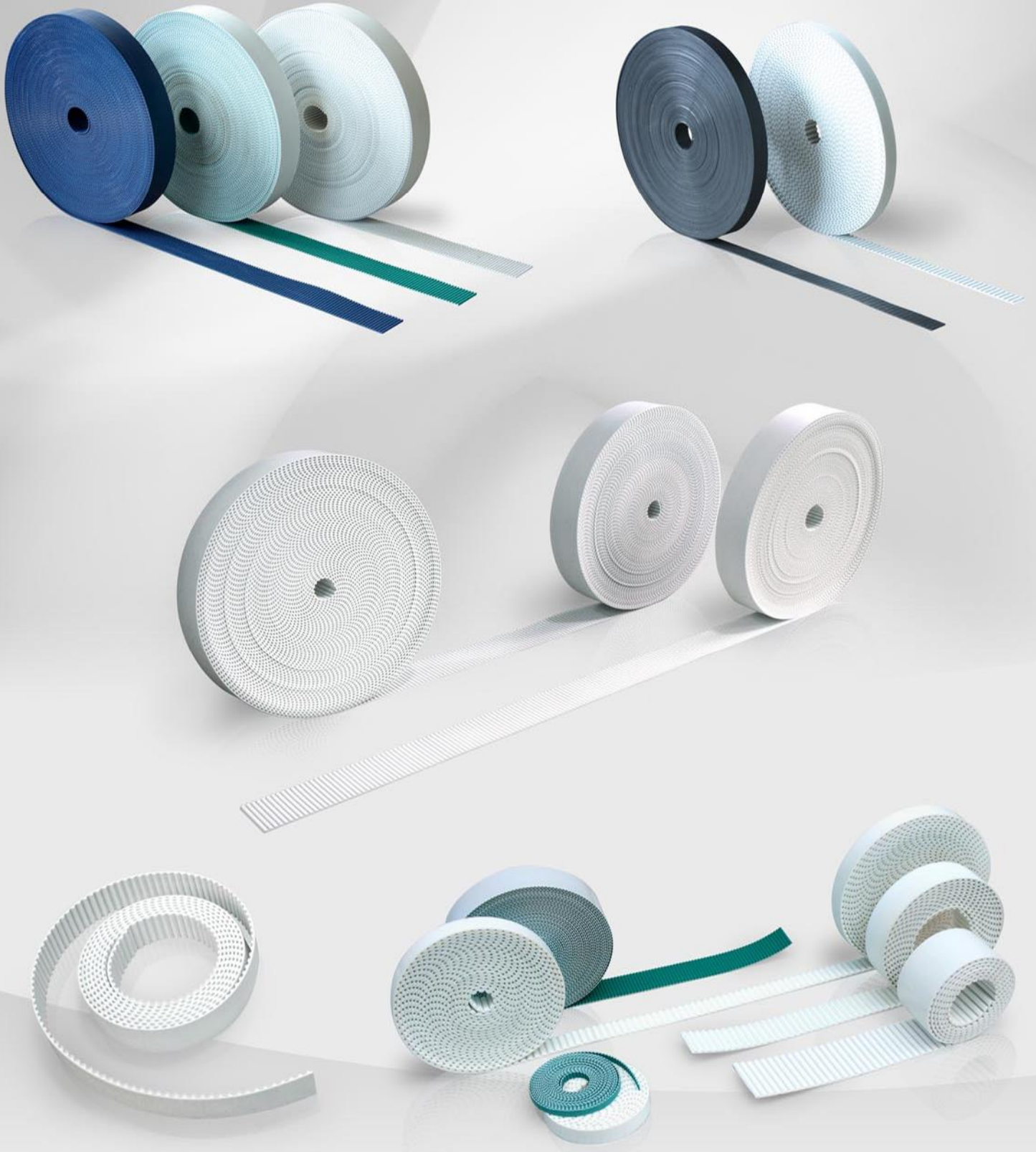

聚氨酯同步带

Polyurethane Timing Belts

产品介绍

- CSHBELT聚氨酯同步带是由热塑性聚氨酯和不同的加强芯线经过挤出过程生产的。高品质的原材料与先进的工艺相结合使产品具有高强度和良好的柔韧性。特别适用于直线运动系统及同步输送系统。
- CSHBELT聚氨酯同步带可以接驳成任意长度环型带以满足不同情况下的输送用途。

Product Introduction

- CSHBELT polyurethane timing belts are manufactured in thermoplastic polyurethane and various tension members by extruded process. High quality raw material and the advanced craft unify enable the product to have the high strength and the good flexibility. Especially suitable for linear motion systems and synchronous conveying systems.
- CSHBELT polyurethane timing belts can be produced to any length by welding to satisfy various conveying use.

结构图 Structure

- 聚氨酯带身 ————— ①
Polyurethane body
- 加强芯线 ————— ②
Tension members
- 齿面尼龙布 ————— ③
Nylon fabric tooth facing

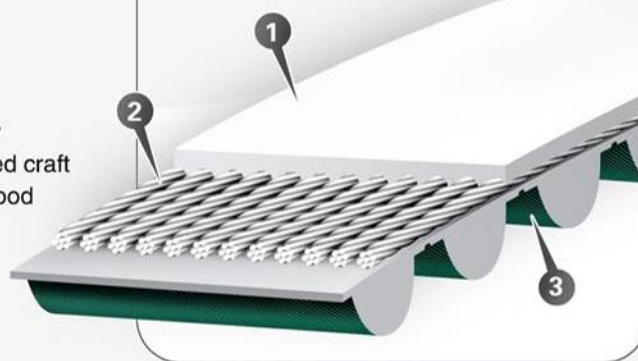

产品特点

- 高精度
- 良好的尺寸稳定性
- 低噪音
- 高耐磨
- 良好的柔韧性
- 免维护
- 预拉力低
- 直线速度可达80米/秒
- 工作温度-20℃~+80℃
- 耐老化、耐水解、耐臭氧
- 耐油、耐脂
- 耐部分酸和碱

Product Characteristics

- High precision
- Good size stability
- Low noise
- Good wear resistant
- Good flexibility
- No maintenance
- Low pretension strength
- the linear velocity can reach 80 m/s
- Working temperature -20℃~+80℃
- Resistant to aging, hydrolysis, ozone
- Resistant to oil, grease
- Resistant to some acids and alkali

订购示例 / Order Example

1	2	3
V	50 T10 8600	CUSTOMER-MADE

1. V – Jointed belt, OE – Open ended belt
2. 50 – Belt width; T10 – Belt type; 8600 – Belt length
3. CUSTOMER-MADE – special manufacture according to customer's requirement

注：可以根据客户需要来样或图纸定做加工。
Customer-made producing and processing against samples or drawings are available.

聚氨酯同步带

Polyurethane Timing Belts

T2.5 Open Ended Specification

- 宽度公差/Width tolerance: **± 0.5mm**
- 标准厚度/Standard thickness: **1.3 ± 0.15mm**
- 标准卷长/Standard roll length: **50m or 100m**
- 卷长公差/Roll length tolerance: **± 1%**
- 皮带轮最少齿数/Minimum number of teeth on pulley:
 - 15 (without back bending)**
 - 18 (with back bending)**
- 张紧轮最小直径/Minimum dia. of idler:
 - 15mm (running on tooth)**
 - 18mm (running on back)**

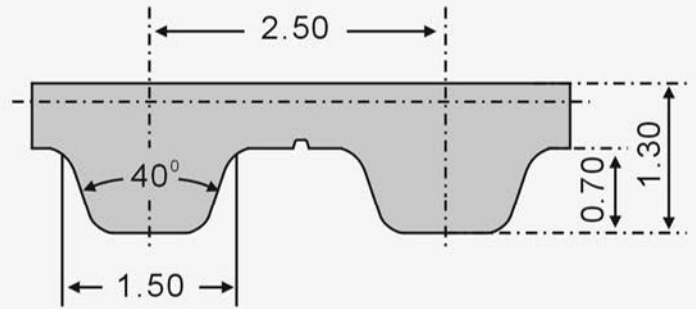

标准材料:
白色热塑性聚氨酯, 邵氏硬度92度

标准加强芯: 钢丝

有最小起定量的客户定制皮带:
- 凯芙拉线芯

Standard material:
white thermoplastic polyurethane, 92 Shore A

Standard cords: steel cords

Customer-made belt with minimum order quantity:
- Kevlar cords

带宽/Belt width(mm)	6	8	10	12	16	20	50
重量/Weight(g/m)	10	15	18	22	29	35	90
断裂强度/Breaking strength(N)	480	640	800	960	1280	1600	4000

聚氨酯同步带

Polyurethane Timing Belts

T5 Open Ended Specification

- 宽度公差/Width tolerance: $\pm 0.5\text{mm}$
- 标准厚度/Standard thickness: $2.2 \pm 0.15\text{mm}$
- 标准卷长/Standard roll length: **50m or 100m**
- 卷长公差/Roll length tolerance: $\pm 1\%$
- 皮带轮最少齿数/Minimum number of teeth on pulley:
 - 10(without back bending)**
 - 15(with back bending)**
- 张紧轮最小直径/Minimum dia. of idler: **30mm**

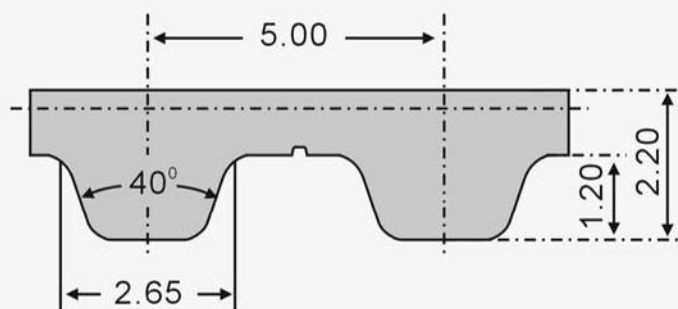

标准材料:

白色热塑性聚氨酯, 邵氏硬度92度

标准加强芯: 钢丝

有最小起定量的客户定制皮带:

- 凯芙拉线芯
- 齿面加尼龙布
- 带背加尼龙布
- 85度PUR
- 天然橡胶
- 档块

Standard material:

white thermoplastic polyurethane, 92 Shore A

Standard cords: steel cords

Customer-made belt with minimum order quantity:

- Kevlar cords
- Nylon fabric teeth
- Nylon fabric back
- PUR 85 Shore A
- Natural rubber
- Cleats

带宽/Belt width(mm)	6	10	16	25	32	50	75	100
重量/Weight(g/m)	15	25	40	60	80	120	180	240
最大负载/Max Traction Load(N)	180	310	500	780	990	1550	2325	3100
断裂强度/Breaking strength(N).	720	1400	1920	3200	4000	6600	8800	12000

接驳带相关资料

- 最小接驳长度为850mm
- 最大负载约为开口带的一半
- 接驳带仅可以做输送用途

Jointed Belt Informations

- Minimum pitch length 850mm
- Max traction load is one half of the open ended belt
- Jointed belt only can be used in conveying systems

聚氨酯同步带

Polyurethane Timing Belts

T10 Open Ended Specification

- 宽度公差/Width tolerance: $\pm 0.5\text{mm}$
- 标准厚度/Standard thickness: $4.5 \pm 0.30\text{mm}$
- 标准卷长/Standard roll length: **50m or 100m**
- 卷长公差/Roll length tolerance: $\pm 1\%$
- 皮带轮最少齿数/Minimum number of teeth on pulley:
 - 12(without back bending)**
 - 20(with back bending)**
- 张紧轮最小直径/Minimum dia. of idler: **60mm**

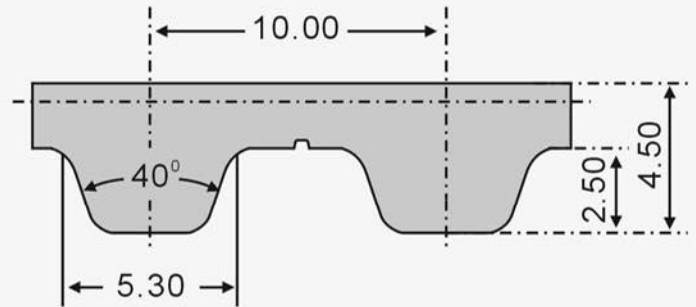

标准材料:

白色热塑性聚氨酯, 邵氏硬度92度

标准加强芯: 钢丝

有最小起定量的客户定制皮带:

- 凯芙拉线芯
- 齿面加尼龙布
- 带背加尼龙布
- 85度PUR
- 天然橡胶
- 档块

Standard material:

white thermoplastic polyurethane, 92 Shore A

Standard cords: steel cords

Customer-made belt with minimum order quantity:

- Kevlar cords
- Nylon fabric teeth
- Nylon fabric back
- PUR 85 Shore A
- Natural rubber
- Cleats

带宽/Belt width(mm)	12	16	25	32	50	75	100	150
重量/Weight(g/m)	60	80	120	155	240	360	480	720
最大负载/Max Traction Load(N)	950	1350	2200	2800	4700	7600	10000	11000
断裂强度/Breaking strength(N)	4000	5500	9000	11200	19000	29000	39000	41000

接驳带相关资料

- 最小接驳长度为850mm
- 最大负载约为开口带的一半
- 接驳带仅可以做输送用途

Jointed Belt Informations

- Minimum pitch length 850mm
- Max traction load is one half of the open ended belt
- Jointed belt only can be used in conveying systems

聚氨酯同步带

Polyurethane Timing Belts

T20 Open Ended Specification

- 宽度公差/Width tolerance: $\pm 1.0\text{mm}$
- 标准厚度/Standard thickness: $8.0 \pm 0.45\text{mm}$
- 标准卷长/Standard roll length: **50m or 100m**
- 卷长公差/Roll length tolerance: $\pm 1\%$
- 皮带轮最少齿数/Minimum number of teeth on pulley:
 - 15(without back bending)**
 - 25(with back bending)**
- 张紧轮最小直径/Minimum dia. of idler: **120mm**

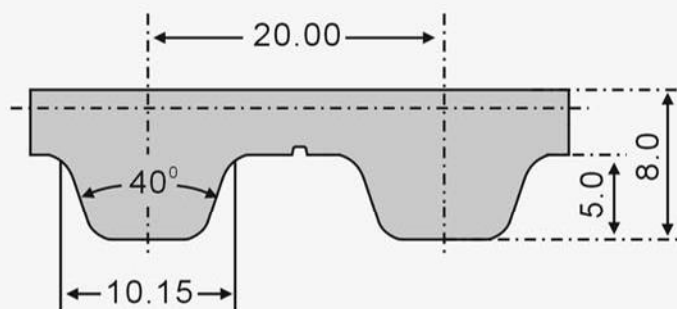

标准材料:

白色热塑性聚氨酯, 邵氏硬度92度

标准加强芯: 钢丝

有最小起定量的客户定制皮带:

- 凯芙拉线芯
- 齿面加尼龙布
- 带背加尼龙布
- 85度PUR
- 天然橡胶
- 档块

Standard material:

white thermoplastic polyurethane, 92 Shore A

Standard cords: steel cords

Customer-made belt with minimum order quantity:

- Kevlar cords
- Nylon fabric teeth
- Nylon fabric back
- PUR 85 Shore A
- Natural rubber
- Cleats

带宽/Belt width(mm)	25	32	50	75	100	150
重量/Weight(g/m)	195	250	390	585	780	1170
最大负载/Max Traction Load(N)	3500	4500	7600	12000	16000	26000
断裂强度/Breaking strength(N)	14000	18000	30000	46000	63000	93000

接驳带相关资料

- 最小接驳长度为1200mm
- 最大负载约为开口带的一半
- 接驳带仅可以做输送用途

Jointed Belt Informations

- Minimum pitch length 1200mm
- Max traction load is one half of the open ended belt
- Jointed belt only can be used in conveying systems

聚氨酯同步带

Polyurethane Timing Belts

AT5 Open Ended Specification

- 宽度公差/Width tolerance: $\pm 0.5\text{mm}$
- 标准厚度/Standard thickness: $2.7 \pm 0.20\text{mm}$
- 标准卷长/Standard roll length: **50m or 100m**
- 卷长公差/Roll length tolerance: $\pm 1\%$
- 皮带轮最少齿数/Minimum number of teeth on pulley:
 - 15(without back bending)**
 - 20(with back bending)**
- 张紧轮最小直径/Minimum dia. of idler:
 - 25mm(running on tooth)**
 - 60mm(running on back)**

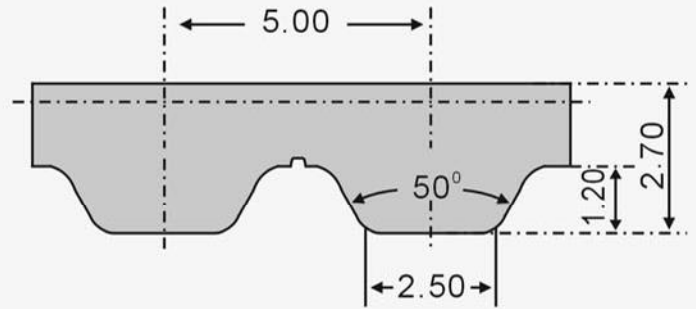

标准材料:
白色热塑性聚氨酯, 邵氏硬度92度

标准加强芯: 钢丝

有最小起定量的客户定制皮带:

- 加强钢丝芯的ATL5
- 凯芙拉线芯
- 齿面加尼龙布
- 带背加尼龙布
- 85度PUR
- 天然橡胶
- 档块

Standard material:
white thermoplastic polyurethane, 92 Shore A

Standard cords: steel cords

Customer-made belt with minimum order quantity:

- Extra strong steel cord to ATL5
- Kevlar cords
- Nylon fabric teeth
- Nylon fabric back
- PUR 85 Shore A
- Natural rubber
- Cleats

带宽/Belt width(mm)	6	10	16	25	32	50	75	100
重量/Weight(g/m)	20	35	60	85	115	170	265	350
最大负载/Max Traction Load(N)	400	600	1000	1650	2000	3500	4800	6500
断裂强度/Breaking strength(N)	1500	2500	4000	6800	8600	14000	18000	24000

接驳带相关资料

- 最小接驳长度为850mm
- 最大负载约为开口带的一半
- 接驳带仅可以做输送用途

Jointed Belt Informations

- Minimum pitch length 850mm
- Max traction load is one half of the open ended belt
- Jointed belt only can be used in conveying systems

聚氨酯同步带

Polyurethane Timing Belts

AT10 Open Ended Specification

- 宽度公差/Width tolerance: $\pm 0.5\text{mm}$
- 标准厚度/Standard thickness: $4.5 \pm 0.30\text{mm}$
- 标准卷长/Standard roll length: **50m or 100m**
- 卷长公差/Roll length tolerance: $\pm 1\%$
- 皮带轮最少齿数/Minimum number of teeth on pulley:
 - 15(without back bending)**
 - 20(with back bending)**
- 张紧轮最小直径/Minimum dia. of idler:
 - 50mm(running on tooth)**
 - 120mm(running on back)**

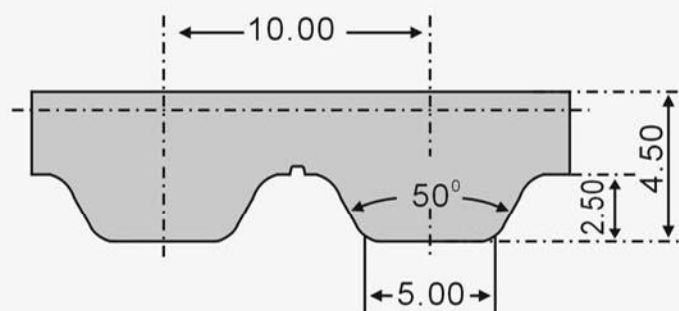

标准材料:
白色热塑性聚氨酯, 邵氏硬度92度

标准加强芯: 钢丝

有最小起订量的客户定制皮带:

- 加强钢丝芯的ATL10
- 凯芙拉线芯
- 齿面加尼龙布
- 带背加尼龙布
- 85度PUR
- 天然橡胶
- 档块

Standard material:
white thermoplastic polyurethane, 92 Shore A

Standard cords: steel cords

Customer-made belt with minimum order quantity:

- Extra strong steel cord to ATL10
- Kevlar cords
- Nylon fabric teeth
- Nylon fabric back
- PUR 85 Shore A
- Natural rubber
- Cleats

带宽/Belt width(mm)	16	25	32	50	75	100	150
重量/Weight(g/m)	105	165	210	325	490	650	975
最大负载/Max Traction Load(N)	2000	3500	4500	7500	12000	16000	25000
断裂强度/Breaking strength(N)	9600	15000	19000	30000	45000	60000	90000

接驳带相关资料

- 最小接驳长度为850mm
- 最大负载约为开口带的一半
- 接驳带仅可以做输送用途

Jointed Belt Informations

- Minimum pitch length 850mm
- Max traction load is one half of the open ended belt
- Jointed belt only can be used in conveying systems

聚氨酯同步带

Polyurethane Timing Belts

AT20 Open Ended Specification

- 宽度公差/Width tolerance: $\pm 1.0\text{mm}$
- 标准厚度/Standard thickness: $8.0 \pm 0.45\text{mm}$
- 标准卷长/Standard roll length: **50m or 100m**
- 卷长公差/Roll length tolerance: $\pm 1\%$
- 皮带轮最少齿数/Minimum number of teeth on pulley:
 - 18(without back bending)**
 - 25(with back bending)**
- 张紧轮最小直径/Minimum dia. of idler:
 - 120mm(running on tooth)**
 - 180mm(running on back)**

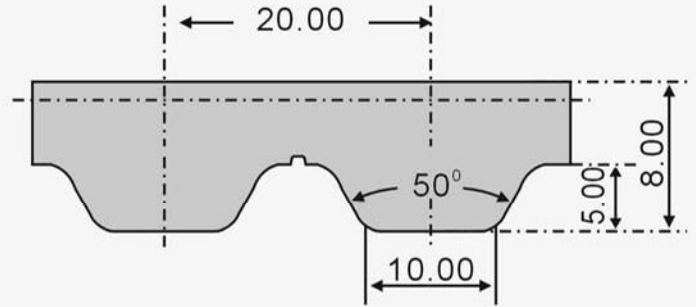

标准材料:
白色热塑性聚氨酯, 邵氏硬度92度

标准加强芯: 钢丝

有最小起定量的客户定制皮带:

- 凯芙拉线芯
- 齿面加尼龙布
- 带背加尼龙布
- 85度PUR
- 天然橡胶
- 档块

Standard material:
white thermoplastic polyurethane, 92 Shore A

Standard cords: steel cords

Customer-made belt with minimum order quantity:

- Kevlar cords
- Nylon fabric teeth
- Nylon fabric back
- PUR 85 Shore A
- Natural rubber
- Cleats

带宽/Belt width(mm)	25	32	50	75	100	150	200
重量/Weight(g/m)	250	320	500	750	1000	1500	2000
最大负载/Max Traction Load(N)	4800	6500	10000	17000	23000	36000	48000
断裂强度/Breaking strength(N)	19000	26000	42000	65000	88000	130000	170000

接驳带相关资料

- 最小接驳长度为1200mm
- 最大负载约为开口带的一半
- 接驳带仅可以做输送用途

Jointed Belt Informations

- Minimum pitch length 1200mm
- Max traction load is one half of the open ended belt
- Jointed belt only can be used in conveying systems

聚氨酯同步带

Polyurethane Timing Belts

MXL Open Ended Specification

- 宽度公差/Width tolerance: $\pm 0.5\text{mm}$
- 标准厚度/Standard thickness: $1.15 \pm 0.15\text{mm}$
- 标准卷长/Standard roll length: **50m or 100m**
- 卷长公差/Roll length tolerance: $\pm 1\%$
- 皮带轮最少齿数/Minimum number of teeth on pulley:
 - 10(without back bending)**
 - 18(with back bending)**
- 张紧轮最小直径/Minimum dia. of idler: **15mm**

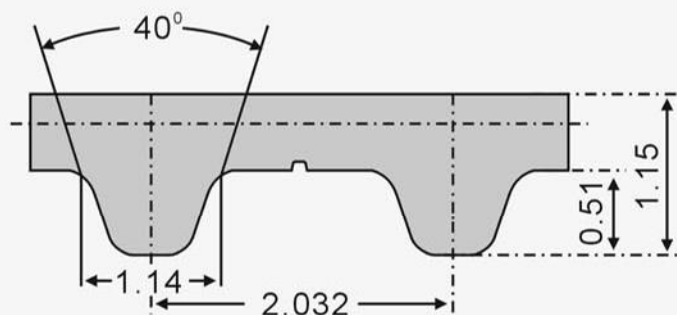

标准材料:

白色热塑性聚氨酯, 邵氏硬度92度

标准加强芯: 钢丝

有最小起定量的客户定制皮带:

- 凯芙拉线芯

Standard material:

white thermoplastic polyurethane, 92 Shore A

Standard cords: steel cords

Customer-made belt with minimum order quantity:

- Kevlar cords

带宽/Belt width(mm)	4	6	10	16	50
重量/Weight(g/m)	5	7	12	20	60
断裂强度/Breaking strength(N)	320	480	800	1280	4000

聚氨酯同步带

Polyurethane Timing Belts

XL Open Ended Specification

- 宽度公差/Width tolerance: $\pm 0.5\text{mm}$
- 标准厚度/Standard thickness: $2.3 \pm 0.30\text{mm}$
- 标准卷长/Standard roll length: **50m or 100m**
- 卷长公差/Roll length tolerance: $\pm 1\%$
- 皮带轮最少齿数/Minimum number of teeth on pulley:
 - 10(without back bending)**
 - 15(with back bending)**
- 张紧轮最小直径/Minimum dia. of idler: **30mm**

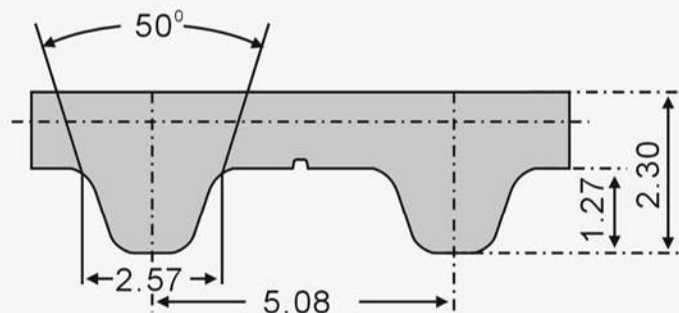

标准材料:

白色热塑性聚氨酯, 邵氏硬度92度

标准加强芯: 钢丝

有最小起定量的客户定制皮带:

- 凯芙拉线芯
- 齿面加尼龙布
- 带背加尼龙布
- 85度PUR
- 天然橡胶
- 档块

Standard material:

white thermoplastic polyurethane, 92 Shore A

Standard cords: steel cords

Customer-made belt with minimum order quantity:

- Kevlar cords
- Nylon fabric teeth
- Nylon fabric back
- PUR 85 Shore A
- Natural rubber
- Cleats

带宽/Belt width(inch)	025	037	050	075	100	150	200
重量/Weight(g/m)	15	20	30	45	60	90	120
最大负载/Max Traction Load(N)	140	220	330	550	770	1200	1600
断裂强度/Breaking strength(N)	600	900	1400	2300	3200	4800	6500

接驳带相关资料

- 最小接驳长度为850mm
- 最大负载约为开口带的一半
- 接驳带仅可以做输送用途

Jointed Belt Informations

- Minimum pitch length 850mm
- Max traction load is one half of the open ended belt
- Jointed belt only can be used in conveying systems

聚氨酯同步带

Polyurethane Timing Belts

L Open Ended Specification

- 宽度公差/Width tolerance: $\pm 0.5\text{mm}$
- 标准厚度/Standard thickness: $3.6 \pm 0.30\text{mm}$
- 标准卷长/Standard roll length: **50m or 100m**
- 卷长公差/Roll length tolerance: $\pm 1\%$
- 皮带轮最少齿数/Minimum number of teeth on pulley:
15(without back bending)
20(with back bending)
- 张紧轮最小直径/Minimum dia. of idler: **60mm**

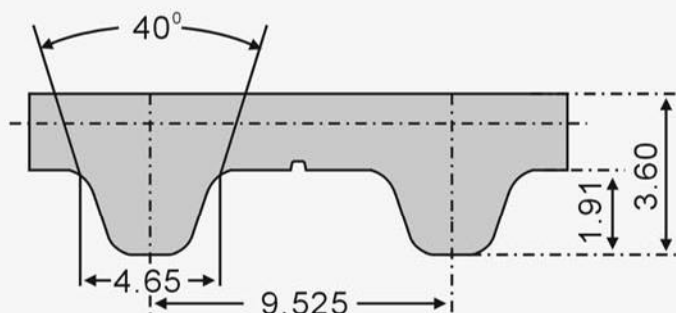

标准材料:

白色热塑性聚氨酯, 邵氏硬度92度

标准加强芯: 钢丝

有最小起定量的客户定制皮带:

- 凯芙拉线芯
- 齿面加尼龙布
- 带背加尼龙布
- 85度PUR
- 天然橡胶
- 档块

Standard material:

white thermoplastic polyurethane, 92 Shore A

Standard cords: steel cords

Customer-made belt with minimum order quantity:

- Kevlar cords
- Nylon fabric teeth
- Nylon fabric back
- PUR 85 Shore A
- Natural rubber
- Cleats

带宽/Belt width(inch)	037	050	075	100	150	200	400
重量/Weight(g/m)	37	50	75	100	150	200	400
最大负载/Max Traction Load(N)	550	750	1200	1600	2500	3500	7000
断裂强度/Breaking strength(N)	2300	3000	5000	7000	11000	14500	25000

接驳带相关资料

- 最小接驳长度为850mm
- 最大负载约为开口带的一半
- 接驳带仅可以做输送用途

Jointed Belt Informations

- Minimum pitch length 850mm
- Max traction load is one half of the open ended belt
- Jointed belt only can be used in conveying systems

聚氨酯同步带

Polyurethane Timing Belts

H Open Ended Specification

- 宽度公差/Width tolerance: $\pm 0.5\text{mm}$
- 标准厚度/Standard thickness: $4.3 \pm 0.30\text{mm}$
- 标准卷长/Standard roll length: **50m or 100m**
- 卷长公差/Roll length tolerance: $\pm 1\%$
- 皮带轮最少齿数/Minimum number of teeth on pulley:
 - 14(without back bending)**
 - 20(with back bending)**
- 张紧轮最小直径/Minimum dia. of idler:
 - 60mm(running on tooth)**
 - 80mm(running on back)**

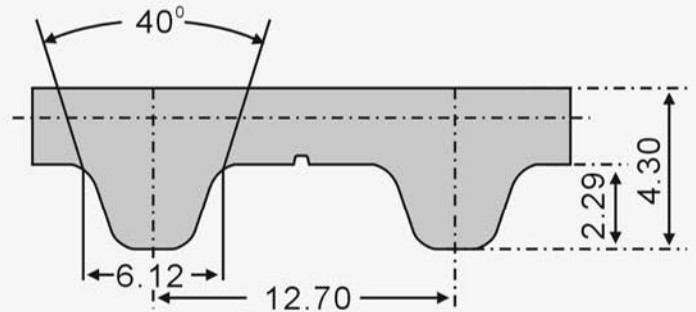

标准材料：
白色热塑性聚氨酯，邵氏硬度92度

标准加强芯：钢丝

- 有最小起定量的客户定制皮带：
- 凯芙拉线芯
 - 齿面加尼龙布
 - 带背加尼龙布
 - 85度PUR
 - 天然橡胶
 - 档块

Standard material:
white thermoplastic polyurethane, 92 Shore A

Standard cords: steel cords

- Customer-made belt with minimum order quantity:
- Kevlar cords
 - Nylon fabric teeth
 - Nylon fabric back
 - PUR 85 Shore A
 - Natural rubber
 - Cleats

带宽/Belt width(inch)	050	075	100	150	200	300	400	600
重量/Weight(g/m)	55	85	115	170	225	335	450	675
最大负载/Max Traction Load(N)	900	1500	2000	3000	4000	6500	8500	11000
断裂强度/Breaking strength(N)	4000	6000	8000	12000	15000	22000	33000	48000

接驳带相关资料

- 最小接驳长度为850mm
- 最大负载约为开口带的一半
- 接驳带仅可以做输送用途

Jointed Belt Informations

- Minimum pitch length 850mm
- Max traction load is one half of the open ended belt
- Jointed belt only can be used in conveying systems

聚氨酯同步带

Polyurethane Timing Belts

XH Open Ended Specification

- 宽度公差/Width tolerance: $\pm 1.0\text{mm}$
- 标准厚度/Standard thickness: $11.2 \pm 0.5\text{mm}$
- 标准卷长/Standard roll length: **50m or 100m**
- 卷长公差/Roll length tolerance: $\pm 1\%$
- 皮带轮最少齿数/Minimum number of teeth on pulley:
 - 18(without back bending)**
 - 20(with back bending)**
- 张紧轮最小直径/Minimum dia. of idler:
 - 150mm(running on tooth)**
 - 180mm(running on back)**

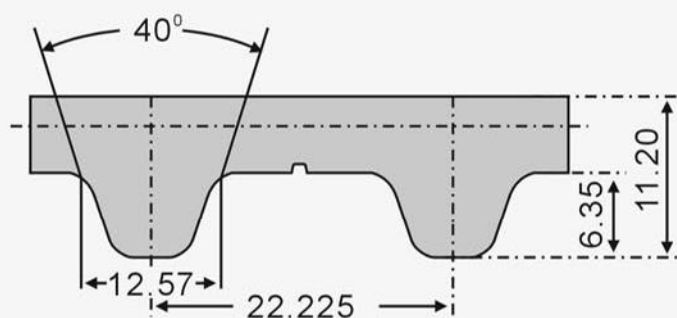

标准材料:
白色热塑性聚氨酯, 邵氏硬度92度

标准加强芯: 钢丝

有最小起订量的客户定制皮带:

- 凯芙拉线芯
- 齿面加尼龙布
- 带背加尼龙布
- 85度PUR
- 天然橡胶
- 档块

Standard material:
white thermoplastic polyurethane, 92 Shore A

Standard cords: steel cords

Customer-made belt with minimum order quantity:

- Kevlar cords
- Nylon fabric teeth
- Nylon fabric back
- PUR 85 Shore A
- Natural rubber
- Cleats

带宽/Belt width(inch)	100	150	200	300	400
重量/Weight(g/m)	265	400	550	800	1060
最大负载/Max Traction Load(N)	3500	5500	7500	12000	18000
断裂强度/Breaking strength(N)	13000	22000	30000	45000	60000

接驳带相关资料

- 最小接驳长度为1500mm
- 最大负载约为开口带的一半
- 接驳带仅可以做输送用途

Jointed Belt Informations

- Minimum pitch length 1500mm
- Max traction load is one half of the open ended belt
- Jointed belt only can be used in conveying systems

聚氨酯同步带

Polyurethane Timing Belts

HTD3M Open Ended Specification

- 宽度公差/Width tolerance: $\pm 0.5\text{mm}$
- 标准厚度/Standard thickness: $2.4 \pm 0.20\text{mm}$
- 标准卷长/Standard roll length: **50m or 100m**
- 卷长公差/Roll length tolerance: $\pm 1\%$
- 皮带轮最少齿数/Minimum number of teeth on pulley:
 - 20(without back bending)**
 - 20(with back bending)**
- 张紧轮最小直径/Minimum dia. of idler: **30mm**

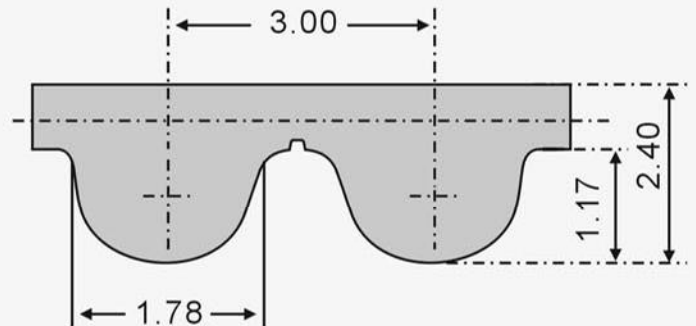

标准材料:

白色热塑性聚氨酯, 邵氏硬度92度

标准加强芯: 钢丝

有最小起定量的客户定制皮带:

- 凯芙拉线芯
- 齿面加尼龙布
- 带背加尼龙布
- 85度PUR
- 天然橡胶
- 档块

Standard material:

white thermoplastic polyurethane, 92 Shore A

Standard cords: steel cords

Customer-made belt with minimum order quantity:

- Kevlar cords
- Nylon fabric teeth
- Nylon fabric back
- PUR 85 Shore A
- Natural rubber
- Cleats

带宽/Belt width(mm)	10	20	25	50
重量/Weight(g/m)	30	65	80	155
最大负载/Max Traction Load(N)	350	700	900	1800
断裂强度/Breaking strength(N)	1500	3000	4000	8000

接驳带相关资料

- 最小接驳长度为850mm
- 最大负载约为开口带的一半
- 接驳带仅可以做输送用途

Jointed Belt Informations

- Minimum pitch length 850mm
- Max traction load is one half of the open ended belt
- Jointed belt only can be used in conveying systems

聚氨酯同步带

Polyurethane Timing Belts

HTD5M Open Ended Specification

- 宽度公差/Width tolerance: $\pm 0.5\text{mm}$
- 标准厚度/Standard thickness: $3.6 \pm 0.20\text{mm}$
- 标准卷长/Standard roll length: **50m or 100m**
- 卷长公差/Roll length tolerance: $\pm 1\%$
- 皮带轮最少齿数/Minimum number of teeth on pulley:
 - 16(without back bending)**
 - 16(with back bending)**
- 张紧轮最小直径/Minimum dia. of idler:
 - 25mm(running on tooth)**
 - 50mm(running on back)**

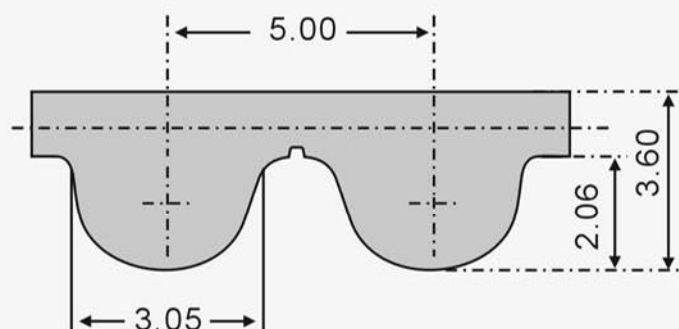

标准材料:

白色热塑性聚氨酯, 邵氏硬度92度

标准加强芯: 钢丝

有最小起订量的客户定制皮带:

- 凯芙拉线芯
- 齿面加尼龙布
- 带背加尼龙布
- 85度PUR
- 天然橡胶
- 档块

Standard material:

white thermoplastic polyurethane, 92 Shore A

Standard cords: steel cords

Customer-made belt with minimum order quantity:

- Kevlar cords
- Nylon fabric teeth
- Nylon fabric back
- PUR 85 Shore A
- Natural rubber
- Cleats

带宽/Belt width(mm)	10	15	25	50	100
重量/Weight(g/m)	45	70	115	225	450
最大负载/Max Traction Load(N)	600	900	1700	3500	7000
断裂强度/Breaking strength(N)	2500	3800	6800	14000	25000

接驳带相关资料

- 最小接驳长度为850mm
- 最大负载约为开口带的一半
- 接驳带仅可以做输送用途

Jointed Belt Informations

- Minimum pitch length 850mm
- Max traction load is one half of the open ended belt
- Jointed belt only can be used in conveying systems

聚氨酯同步带

Polyurethane Timing Belts

HTD8M Open Ended Specification

- 宽度公差/Width tolerance: $\pm 0.5\text{mm}$
- 标准厚度/Standard thickness: $5.6 \pm 0.30\text{mm}$
- 标准卷长/Standard roll length: **50m or 100m**
- 卷长公差/Roll length tolerance: $\pm 1\%$
- 皮带轮最少齿数/Minimum number of teeth on pulley:
 - 20(without back bending)**
 - 22(with back bending)**
- 张紧轮最小直径/Minimum dia. of idler:
 - 50mm(running on tooth)**
 - 100mm(running on back)**

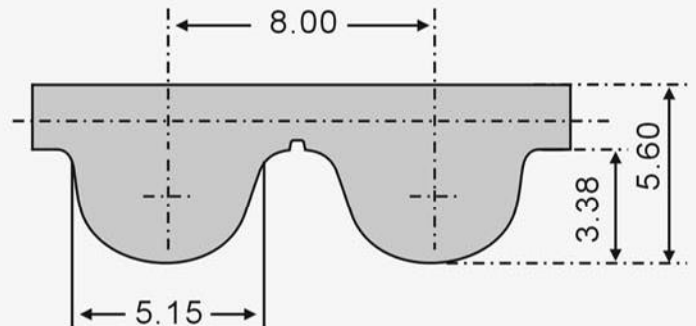

标准材料：
白色热塑性聚氨酯，邵氏硬度92度

标准加强芯：钢丝

- 有最小起定量的客户定制皮带：
- 凯芙拉线芯
 - 齿面加尼龙布
 - 带背加尼龙布
 - 85度PUR
 - 天然橡胶
 - 档块

Standard material:
white thermoplastic polyurethane, 92 Shore A

Standard cords: steel cords

- Customer-made belt with minimum order quantity:
- Kevlar cords
 - Nylon fabric teeth
 - Nylon fabric back
 - PUR 85 Shore A
 - Natural rubber
 - Cleats

带宽/Belt width(mm)	10	15	20	30	50	85	100	150
重量/Weight(g/m)	70	105	140	210	350	590	690	1035
最大负载/Max Traction Load(N)	1300	2000	2900	4500	7600	14000	16000	22000
断裂强度/Breaking strength(N)	5000	8000	11000	18000	30000	53000	63000	94000

接驳带相关资料

- 最小接驳长度为850mm
- 最大负载约为开口带的一半
- 接驳带仅可以做输送用途

Jointed Belt Informations

- Minimum pitch length 850mm
- Max traction load is one half of the open ended belt
- Jointed belt only can be used in conveying systems

聚氨酯同步带

Polyurethane Timing Belts

HTD14M Open Ended Specification

- 宽度公差/Width tolerance: $\pm 1.0\text{mm}$
- 标准厚度/Standard thickness: $10.0 \pm 0.45\text{mm}$
- 标准卷长/Standard roll length: **50m or 100m**
- 卷长公差/Roll length tolerance: $\pm 1\%$
- 皮带轮最少齿数/Minimum number of teeth on pulley:
 - 26(without back bending)**
 - 28(with back bending)**
- 张紧轮最小直径/Minimum dia. of idler:
 - 120mm(running on tooth)**
 - 180mm(running on back)**

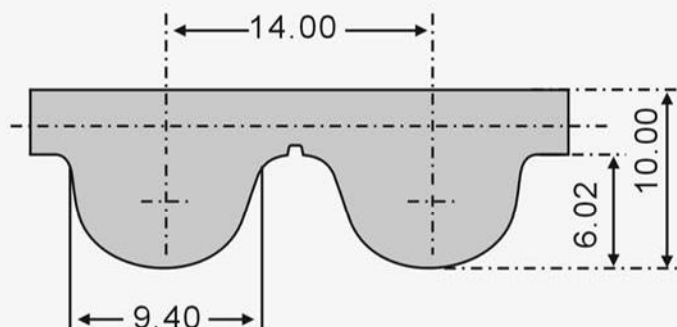

标准材料:

白色热塑性聚氨酯, 邵氏硬度92度

标准加强芯: 钢丝

有最小起订量的客户定制皮带:

- 凯芙拉线芯
- 齿面加尼龙布
- 带背加尼龙布
- 85度PUR
- 天然橡胶
- 档块

Standard material:

white thermoplastic polyurethane, 92 Shore A

Standard cords: steel cords

Customer-made belt with minimum order quantity:

- Kevlar cords
- Nylon fabric teeth
- Nylon fabric back
- PUR 85 Shore A
- Natural rubber
- Cleats

带宽/Belt width(mm)	25	40	55	85	100	115
重量/Weight(g/m)	275	440	605	935	1100	1265
最大负载/Max Traction Load(N)	5000	8000	12000	19000	23000	28000
断裂强度/Breaking strength(N)	20000	30000	45000	73000	88000	100000

接驳带相关资料

- 最小接驳长度为1500mm
- 最大负载约为开口带的一半
- 接驳带仅可以做输送用途

Jointed Belt Informations

- Minimum pitch length 1500mm
- Max traction load is one half of the open ended belt
- Jointed belt only can be used in conveying systems

聚氨酯同步带

Polyurethane Timing Belts

S2M Open Ended Specification

- 宽度公差/Width tolerance: $\pm 0.5\text{mm}$
- 标准厚度/Standard thickness: $1.36 \pm 0.30\text{mm}$
- 标准卷长/Standard roll length: **50m or 100m**
- 卷长公差/Roll length tolerance: $\pm 1\%$
- 皮带轮最少齿数/Minimum number of teeth on pulley:
 - 12(without back bending)**
 - 18(with back bending)**
- 张紧轮最小直径/Minimum dia. of idler:
 - 15mm(running on tooth)**

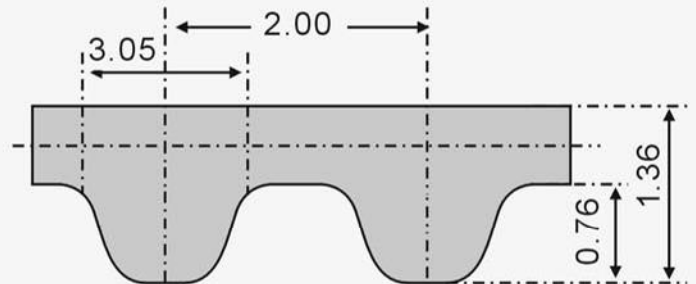

标准材料:
白色热塑性聚氨酯, 邵氏硬度92度

标准加强芯: 钢丝

有最小起定量的客户定制皮带:
- 凯芙拉线芯

Standard material:
white thermoplastic polyurethane, 92 Shore A

Standard cords: steel cords

Customer-made belt with minimum order quantity:
- Kevlar cords

带宽/Belt width(mm)	6	8	10	12	16	20	50
重量/Weight(g/m)	10	15	18	22	29	35	90
断裂强度/Breaking strength(N)	480	640	800	960	1280	1600	4000

接驳带相关资料

- 最小接驳长度为850mm
- 最大负载约为开口带的一半
- 接驳带仅可以做输送用途

Jointed Belt Informations

- Minimum pitch length 850mm
- Max traction load is one half of the open ended belt
- Jointed belt only can be used in conveying systems

聚氨酯同步带

Polyurethane Timing Belts

S3M Open Ended Specification

- 宽度公差/Width tolerance: $\pm 0.5\text{mm}$
- 标准厚度/Standard thickness: $2.2 \pm 0.20\text{mm}$
- 标准卷长/Standard roll length: **50m or 100m**
- 卷长公差/Roll length tolerance: $\pm 1\%$
- 皮带轮最少齿数/Minimum number of teeth on pulley:
 - 20(without back bending)**
 - 20(with back bending)**
- 张紧轮最小直径/Minimum dia. of idler:
 - 30mm(running on tooth)**

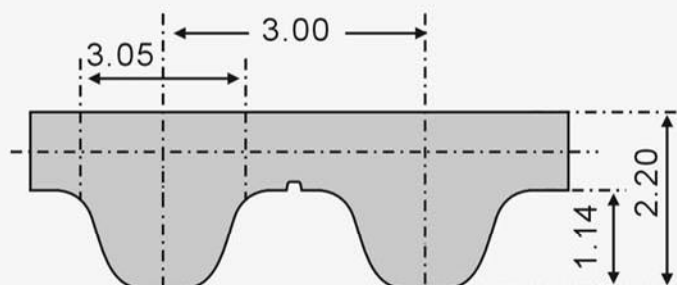

标准材料:
白色热塑性聚氨酯, 邵氏硬度92度

标准加强芯: 钢丝

有最小起定量的客户定制皮带:

- 凯芙拉线芯
- 带背加尼龙布
- 85度PUR
- 天然橡胶
- 档块

Standard material:
white thermoplastic polyurethane, 92 Shore A

Standard cords: steel cords

Customer-made belt with minimum order quantity:

- Kevlar cords
- Nylon fabric back
- PUR 85 Shore A
- Natural rubber
- Cleats

带宽/Belt width(mm)	10	15	25	50
重量/Weight(g/m)	30	65	80	155
最大负载/Max Traction Load(N)	350	700	900	1800
断裂强度/Breaking strength(N)	1500	3000	4000	8000

接驳带相关资料

- 最小接驳长度为850mm
- 最大负载约为开口带的一半
- 接驳带仅可以做输送用途

Jointed Belt Informations

- Minimum pitch length 850mm
- Max traction load is one half of the open ended belt
- Jointed belt only can be used in conveying systems

聚氨酯同步带

Polyurethane Timing Belts

S5M Open Ended Specification

- 宽度公差/Width tolerance: $\pm 0.5\text{mm}$
- 标准厚度/Standard thickness: $3.4 \pm 0.20\text{mm}$
- 标准卷长/Standard roll length: **50m or 100m**
- 卷长公差/Roll length tolerance: $\pm 1\%$
- 皮带轮最少齿数/Minimum number of teeth on pulley:
 - 12(without back bending)**
 - 13(with back bending)**
- 张紧轮最小直径/Minimum dia. of idler:
 - 20mm(running on tooth)**
 - 60mm(running on back)**

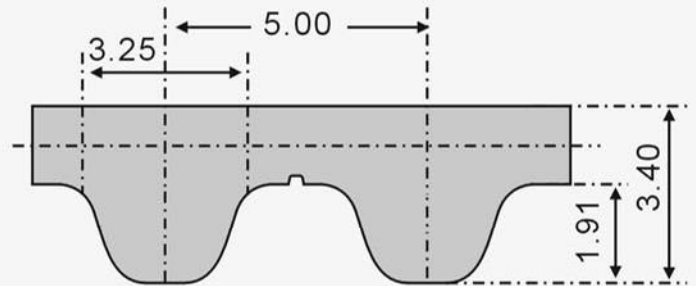

标准材料:
黑色热塑性聚氨酯, 邵氏硬度92度

标准加强芯: 钢丝

- 有最小起定量的客户定制皮带:
- 凯芙拉线芯
 - 齿面加尼龙布
 - 带背加尼龙布
 - 85度PUR
 - 天然橡胶
 - 档块

Standard material:
black thermoplastic polyurethane, 92 Shore A

Standard cords: steel cords

- Customer-made belt with minimum order quantity:
- Kevlar cords
 - Nylon fabric teeth
 - Nylon fabric back
 - PUR 85 Shore A
 - Natural rubber
 - Cleats

带宽/Belt width(mm)	10	15	25	50	100
重量/Weight(g/m)	45	65	110	220	430
最大负载/Max Traction Load(N)	600	900	1700	3500	7000
断裂强度/Breaking strength(N)	2500	3800	6800	14000	25000

接驳带相关资料

- 最小接驳长度为850mm
- 最大负载约为开口带的一半
- 接驳带仅可以做输送用途

Jointed Belt Informations

- Minimum pitch length 850mm
- Max traction load is one half of the open ended belt
- Jointed belt only can be used in conveying systems

聚氨酯同步带

Polyurethane Timing Belts

S8M Open Ended Specification

- 宽度公差/Width tolerance: $\pm 0.5\text{mm}$
- 标准厚度/Standard thickness: $5.3 \pm 0.30\text{mm}$
- 标准卷长/Standard roll length: **50m or 100m**
- 卷长公差/Roll length tolerance: $\pm 1\%$
- 皮带轮最少齿数/Minimum number of teeth on pulley:
 - 20(without back bending)**
 - 24(with back bending)**
- 张紧轮最小直径/Minimum dia. of idler:
 - 50mm(running on tooth)**
 - 100mm(running on back)**

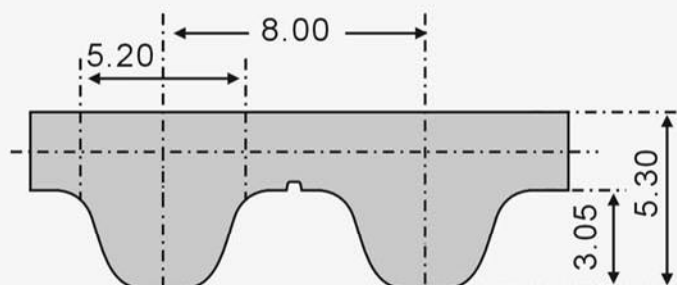

标准材料:

黑色热塑性聚氨酯, 邵氏硬度92度

标准加强芯: 钢丝

有最小起订量的客户定制皮带:

- 凯芙拉线芯
- 齿面加尼龙布
- 带背加尼龙布
- 85度PUR
- 天然橡胶
- 档块

Standard material:

black thermoplastic polyurethane, 92 Shore A

Standard cords: steel cords

Customer-made belt with minimum order quantity:

- Kevlar cords
- Nylon fabric teeth
- Nylon fabric back
- PUR 85 Shore A
- Natural rubber
- Cleats

带宽/Belt width(mm)	10	12	15	20	30	50	85	100
重量/Weight(g/m)	65	80	100	130	195	325	550	650
最大负载/Max Traction Load(N)	1300	1500	2000	2900	4500	7600	14000	16000
断裂强度/Breaking strength(N)	5000	6000	8000	11000	18000	30000	53000	63000

接驳带相关资料

- 最小接驳长度为850mm
- 最大负载约为开口带的一半
- 接驳带仅可以做输送用途

Jointed Belt Informations

- Minimum pitch length 850mm
- Max traction load is one half of the open ended belt
- Jointed belt only can be used in conveying systems

聚氨酯同步带

Polyurethane Timing Belts

S14M Open Ended Specification

- 宽度公差/Width tolerance: $\pm 1.0\text{mm}$
- 标准厚度/Standard thickness: $10.20 \pm 0.45\text{mm}$
- 标准卷长/Standard roll length: **50m or 100m**
- 卷长公差/Roll length tolerance: $\pm 1\%$
- 皮带轮最少齿数/Minimum number of teeth on pulley:
 - 32(without back bending)**
 - 35(with back bending)**
- 张紧轮最小直径/Minimum dia. of idler:
 - 145mm(running on tooth)**
 - 250mm(running on back)**

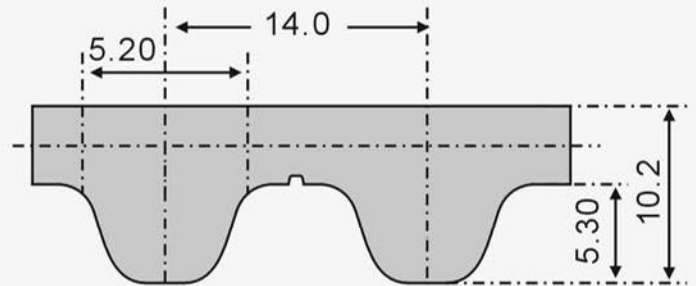

标准材料:
白色热塑性聚氨酯, 邵氏硬度92度

Standard material:
white thermoplastic polyurethane, 92 Shore A

标准加强芯: 钢丝

Standard cords: steel cords

有最小起定量的客户定制皮带:
- 凯芙拉线芯
- 带背加尼龙布
- 85度PUR
- 天然橡胶
- 档块

Customer-made belt with minimum order quantity:
- Kevlar cords
- Nylon fabric back
- PUR 85 Shore A
- Natural rubber
- Cleats

带宽/Belt width(mm)	40	55	85	100
重量/Weight(g/m)	440	605	935	1100
最大负载/Max Traction Load(N)	8000	12000	19000	23000
断裂强度/Breaking strength(N)	30000	45000	73000	88000

接驳带相关资料

- 最小接驳长度为1500mm
- 最大负载约为开口带的一半
- 接驳带仅可以做输送用途

Jointed Belt Informations

- Minimum pitch length 1500mm
- Max traction load is one half of the open ended belt
- Jointed belt only can be used in conveying systems

聚氨酯同步带

Polyurethane Timing Belts

RPP5M Open Ended Specification

- 宽度公差/Width tolerance: $\pm 0.5\text{mm}$
- 标准厚度/Standard thickness: $3.6 \pm 0.20\text{mm}$
- 标准卷长/Standard roll length: **50m or 100m**
- 卷长公差/Roll length tolerance: $\pm 1\%$
- 皮带轮最少齿数/Minimum number of teeth on pulley:
 - 12(without back bending)**
 - 13(with back bending)**
- 张紧轮最小直径/Minimum dia. of idler:
 - 20mm(running on tooth)**
 - 60mm(running on back)**

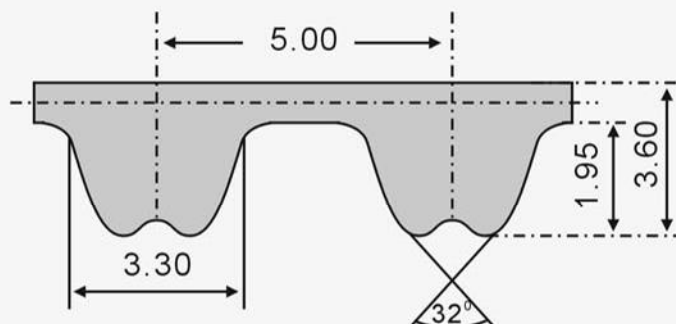

标准材料:

白色热塑性聚氨酯, 邵氏硬度92度, 齿面加尼龙布

标准加强芯: 钢丝

有最小起定量的客户定制皮带:

- 凯芙拉线芯
- 带背加尼龙布
- 85度PUR
- 天然橡胶
- 档块

Standard material:

white thermoplastic polyurethane, 92 Shore A, nylon fabric teeth

Standard cords: steel cords

Customer-made belt with minimum order quantity:

- Kevlar cords
- Nylon fabric back
- PUR 85 Shore A
- Natural rubber
- Cleats

带宽/Belt width(mm)	10	15	25	30	50	75	100
重量/Weight(g/m)	45	70	115	135	225	335	450
最大负载/Max Traction Load(N)	600	900	1700	2000	3500	5500	6500
断裂强度/Breaking strength(N)	2500	3800	6800	8300	14000	21000	26000

接驳带相关资料

- 最小接驳长度为850mm
- 最大负载约为开口带的一半
- 接驳带仅可以做输送用途

Jointed Belt Informations

- Minimum pitch length 850mm
- Max traction load is one half of the open ended belt
- Jointed belt only can be used in conveying systems

聚氨酯同步带

Polyurethane Timing Belts

RPP8M Open Ended Specification

- 宽度公差/Width tolerance: $\pm 0.5\text{mm}$
- 标准厚度/Standard thickness: $5.4 \pm 0.30\text{mm}$
- 标准卷长/Standard roll length: **50m or 100m**
- 卷长公差/Roll length tolerance: $\pm 1\%$
- 皮带轮最少齿数/Minimum number of teeth on pulley:
 - 18(without back bending)**
 - 20(with back bending)**
- 张紧轮最小直径/Minimum dia. of idler:
 - 45mm(running on tooth)**
 - 100mm(running on back)**

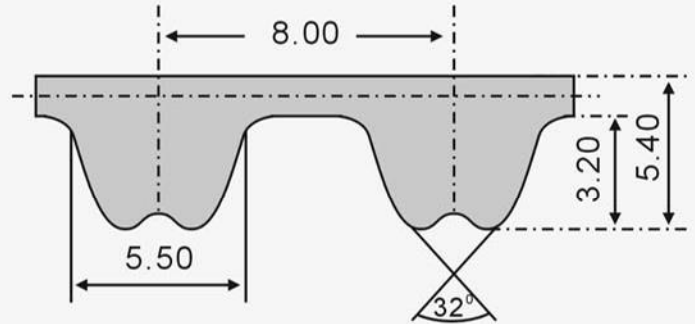

标准材料:
白色热塑性聚氨酯, 邵氏硬度92度,
齿面加尼龙布

标准加强芯: 钢丝

有最小起定量的客户定制皮带:

- 凯芙拉线芯
- 带背加尼龙布
- 85度PUR
- 天然橡胶
- 档块

Standard material:
white thermoplastic polyurethane, 92 Shore A, nylon fabric teeth

Standard cords: steel cords

Customer-made belt with minimum order quantity:

- Kevlar cords
- Nylon fabric back
- PUR 85 Shore A
- Natural rubber
- Cleats

带宽/Belt width(mm)	10	15	20	30	50	85	100
重量/Weight(g/m)	65	100	135	200	330	560	660
最大负载/Max Traction Load(N)	1300	2000	2900	4500	7600	14000	16000
断裂强度/Breaking strength(N)	5000	8000	11000	18000	30000	53000	63000

接驳带相关资料

- 最小接驳长度为850mm
- 最大负载约为开口带的一半
- 接驳带仅可以做输送用途

Jointed Belt Informations

- Minimum pitch length 850mm
- Max traction load is one half of the open ended belt
- Jointed belt only can be used in conveying systems

聚氨酯同步带

Polyurethane Timing Belts

RPP14M Open Ended Specification

- 宽度公差/Width tolerance: $\pm 1.0\text{mm}$
- 标准厚度/Standard thickness: $10.0 \pm 0.45\text{mm}$
- 标准卷长/Standard roll length: **50m or 100m**
- 卷长公差/Roll length tolerance: $\pm 1\%$
- 皮带轮最少齿数/Minimum number of teeth on pulley:
 - 32(without back bending)**
 - 35(with back bending)**
- 张紧轮最小直径/Minimum dia. of idler:
 - 145mm(running on tooth)**
 - 250mm(running on back)**

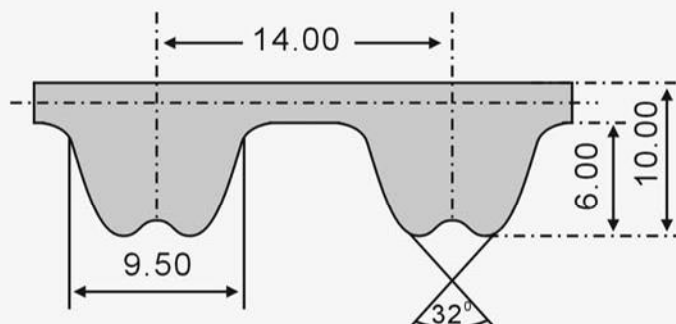

标准材料:

白色热塑性聚氨酯, 邵氏硬度92度, 齿面加尼龙布

标准加强芯: 钢丝

有最小起定量的客户定制皮带:

- 凯芙拉线芯
- 带背加尼龙布
- 85度PUR
- 天然橡胶
- 档块

Standard material:

white thermoplastic polyurethane, 92 Shore A, nylon fabric teeth

Standard cords: steel cords

Customer-made belt with minimum order quantity:

- Kevlar cords
- Nylon fabric back
- PUR 85 Shore A
- Natural rubber
- Cleats

带宽/Belt width(mm)	40	55	85	115	150
重量/Weight(g/m)	440	605	935	1265	1650
最大负载/Max Traction Load(N)	8000	12000	19000	28000	35000
断裂强度/Breaking strength(N)	30000	45000	73000	100000	140000

接驳带相关资料

- 最小接驳长度为1500mm
- 最大负载约为开口带的一半
- 接驳带仅可以做输送用途

Jointed Belt Informations

- Minimum pitch length 1500mm
- Max traction load is one half of the open ended belt
- Jointed belt only can be used in conveying systems

聚氨酯同步带

Polyurethane Timing Belts

P1 Open Ended Specification

- 宽度公差/Width tolerance: $\pm 0.5\text{mm}$
- 标准厚度/Standard thickness: **1.0mm**
- 标准卷长/Standard roll length: **50m or 100m**
- 卷长公差/Roll length tolerance: $\pm 1\%$
- 皮带轮最小直径/Minimum dia. of pulley:
 - 16mm(without back bending)**
 - 25mm(with back bending)**
- 张紧轮最小直径/Minimum dia. of idler: **30mm**



标准材料:

黑色或白色热塑性聚氨酯, 邵氏硬度92度

标准加强芯: 钢丝

有最小起定量的客户定制皮带:

- 齿面加尼龙布
- 带背加尼龙布

Standard material:

black or white thermoplastic polyurethane, 92 Shore A

Standard cords: steel cords

Customer-made belt with minimum order quantity:

- Nylon fabric teeth
- Nylon fabric back

带宽/Belt width(mm)	10	20
重量/Weight(g/m)	20	40
最大负载/Max Traction Load(N)	400	900
断裂强度/Breaking strength(N)	1800	3700

聚氨酯同步带

Polyurethane Timing Belts

P2 Open Ended Specification

- 宽度公差/Width tolerance: $\pm 0.5\text{mm}$
- 标准厚度/Standard thickness: **2.0mm**
- 标准卷长/Standard roll length: **50m or 100m**
- 卷长公差/Roll length tolerance: $\pm 1\%$
- 皮带轮最小直径/Minimum dia. of pulley:
 - 45mm(without back bending)**
 - 50mm(with back bending)**
- 张紧轮最小直径/Minimum dia. of idler:
 - 50mm(running on tooth)**
 - 90mm(running on back)**



标准材料:

黑色或白色热塑性聚氨酯, 邵氏硬度92度

标准加强芯: 钢丝

有最小起定量的客户定制皮带:

- 齿面加尼龙布
- 带背加尼龙布

Standard material:

black or white thermoplastic polyurethane, 92 Shore A

Standard cords: steel cords

Customer-made belt with minimum order quantity:

- Nylon fabric teeth
- Nylon fabric back

带宽/Belt width(mm)	25	50	75	100
重量/Weight(g/m)	125	250	375	500
最大负载/Max Traction Load(N)	2500	5000	7500	10000
断裂强度/Breaking strength(N)	10000	20000	30000	40000

接驳带相关资料

- 最小接驳长度为850mm
- 最大负载约为开口带的一半
- 接驳带仅可以做输送用途

Jointed Belt Informations

- Minimum pitch length 850mm
- Max traction load is one half of the open ended belt
- Jointed belt only can be used in conveying systems

聚氨酯同步带

Polyurethane Timing Belts

P3 Open Ended Specification

- 宽度公差/Width tolerance: **± 0.5mm**
- 标准厚度/Standard thickness: **3.0mm**
- 标准卷长/Standard roll length: **50m or 100m**
- 卷长公差/Roll length tolerance: **± 1%**
- 皮带轮最小直径/Minimum dia. of pulley:
 - 100mm(without back bending)**
 - 110mm(with back bending)**
- 张紧轮最小直径/Minimum dia. of idler:
 - 100mm(running on tooth)**
 - 150mm(running on back)**



标准材料:

黑色或白色热塑性聚氨酯, 邵氏硬度92度

标准加强芯: 钢丝

有最小起定量的客户定制皮带:

- 齿面加尼龙布
- 带背加尼龙布

Standard material:

black or white thermoplastic polyurethane, 92 Shore A

Standard cords: steel cords

Customer-made belt with minimum order quantity:

- Nylon fabric teeth
- Nylon fabric back

带宽/Belt width(mm)	25	50	100
重量/Weight(g/m)	175	350	690
最大负载/Max Traction Load(N)	2500	5000	10000
断裂强度/Breaking strength(N)	10000	20000	40000

接驳带相关资料

- 最小接驳长度为850mm
- 最大负载约为开口带的一半
- 接驳带仅可以做输送用途

Jointed Belt Informations

- Minimum pitch length 850mm
- Max traction load is one half of the open ended belt
- Jointed belt only can be used in conveying systems

聚氨酯同步带

Polyurethane Timing Belts

P4 Open Ended Specification

- 宽度公差/Width tolerance: $\pm 0.5\text{mm}$
- 标准厚度/Standard thickness: **4.0mm**
- 标准卷长/Standard roll length: **50m or 100m**
- 卷长公差/Roll length tolerance: $\pm 1\%$
- 皮带轮最小直径/Minimum dia. of pulley:
 - 100mm(without back bending)**
 - 110mm(with back bending)**
- 张紧轮最小直径/Minimum dia. of idler:
 - 100mm(running on tooth)**
 - 150mm(running on back)**



标准材料:

黑色或白色热塑性聚氨酯, 邵氏硬度92度

标准加强芯: 钢丝

有最小起定量的客户定制皮带:

- 齿面加尼龙布
- 带背加尼龙布

Standard material:

black or white thermoplastic polyurethane, 92 Shore A

Standard cords: steel cords

Customer-made belt with minimum order quantity:

- Nylon fabric teeth
- Nylon fabric back

带宽/Belt width(mm)	25	50	100
重量/Weight(g/m)	230	450	900
最大负载/Max Traction Load(N)	7500	15000	30000
断裂强度/Breaking strength(N)	30000	60000	120000

接驳带相关资料

- 最小接驳长度为850mm
- 最大负载约为开口带的一半
- 接驳带仅可以做输送用途

Jointed Belt Informations

- Minimum pitch length 850mm
- Max traction load is one half of the open ended belt
- Jointed belt only can be used in conveying systems

TT5齿型同步带

TT5 Timing Belts

产品介绍

- CSHBELT TT5 齿型同步带是由热塑性聚氨酯和不同的加强芯线经过挤出过程生产的。高品质的原材料与先进的工艺相结合使产品具有高强度和良好的柔韧性。适用于针织圆机。

Product Introduction

- CSHBELT TT5 timing belts are manufactured in thermoplastic polyurethane and various tension members by extruded process. High quality raw material and the advanced craft unify enable the product to have the high strength and the good flexibility. Especially suitable for knitting circular machine.

实物图 Structure



产品特点

- 蓝色或白色
- 高强度，钢丝或者凯芙拉芯线任选
- 宽广的长度范围可供选择
- 同时具有开口同步带的特性

Product Characteristics

- Blue or white color
- High strength, steel cord or kevlar cord
- Wide range pitch length to meet the requirement
- All the characteristics of open ended belt

标准型号 / Standard Range

TT5-5000mm	TT5-6600mm	TT5-8200mm	TT5-9800mm	TT5-11400mm
TT5-5200mm	TT5-6800mm	TT5-8400mm	TT5-10000mm	TT5-11600mm
TT5-5400mm	TT5-7000mm	TT5-8600mm	TT5-10200mm	TT5-11800mm
TT5-5600mm	TT5-7200mm	TT5-8800mm	TT5-10400mm	TT5-12000mm
TT5-5800mm	TT5-7400mm	TT5-9000mm	TT5-10600mm	TT5-12200mm
TT5-6000mm	TT5-7600mm	TT5-9200mm	TT5-10800mm	TT5-12400mm
TT5-6200mm	TT5-7800mm	TT5-9400mm	TT5-11000mm	TT5-12600mm
TT5-6400mm	TT5-8000mm	TT5-9600mm	TT5-11200mm	TT5-12800mm

订购示例 / Order Example

1	2	3	4
V	10 TT5 8600	K	BLUE

- V – Jointed belt, OE – Open ended belt
- 10 – Belt width; TT5 – Belt type; 8600 – Belt length
- K – kevlar cord, S – Steel cord
- BLUE – Belt color is blue, WHITE – Belt color is white

TT5齿型同步带

TT5 Timing Belts

TT5 Open Ended Specification

- 宽度公差/Width tolerance: $\pm 0.5\text{mm}$
- 标准厚度/Standard thickness: **2.90+0.20mm**
- 标准卷长/Standard roll length: **50m or 100m**
- 卷长公差/Roll length tolerance: $\pm 1\%$
- 皮带轮最少齿数/Minimum number of teeth on pulley:
 - 12(without back bending)**
 - 15(with back bending)**
- 张紧轮最小直径/Minimum dia. of idler:
 - 30mm(running on tooth)**

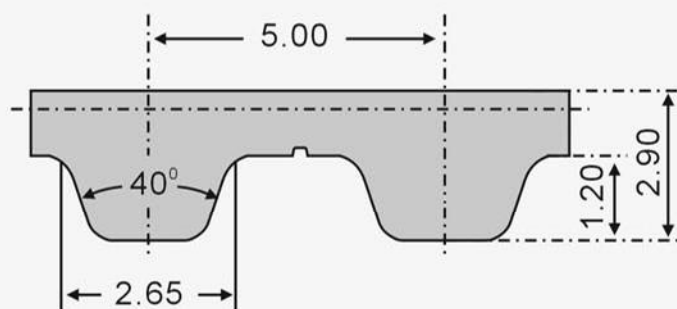

标准材料:

白色或者蓝色热塑性聚氨酯, 邵氏硬度85度

标准加强芯: 钢丝或凯芙拉线芯

Standard material:

white or blue thermoplastic polyurethane, 85 Shore A

Standard cords: steel cords or kevlar cord

	Steel cord	Kevlar cord
带宽/Belt width(mm)	10	10
重量/Weight(g/m)	30	29
最大负载/Max Traction Load(N)	320	760
断裂强度/Breaking strength(N)	1300	3000

接驳带相关资料

- 最小接驳长度为850mm
- 最大负载约为开口带的一半
- 接驳带仅可以做输送用途

Jointed Belt Informations

- Minimum pitch length 850mm
- Max traction load is one half of the open ended belt
- Jointed belt only can be used in conveying systems

CSHFLEX聚氨酯无缝同步带

CSHFLEX Polyurethane Timing Belts



CSHFLEX聚氨酯无缝同步带

CSHFLEX Polyurethane Timing Belts

产品介绍

- CSHFLEX聚氨酯无缝同步带是由热塑性聚氨酯和连续的螺旋型加强芯线经过挤出过程生产的。高品质的原材料与先进的工艺相结合使产品具有高强度特性。特别适用于高负载输送系统及动力传动系统。
- CSHFLEX聚氨酯无缝同步带是真正的无缝环型同步带，生产长度2.500米~20.000米。

Product Introduction

- CSHFLEX polyurethane timing belts are manufactured in thermoplastic polyurethane and continuous spiral tension members by extruded process. High quality raw material and the advanced craft unify enable the product to have high strength. Especially suitable for high traction load conveying systems and power transmission systems.

结构图 Structure



- CSHFLEX polyurethane timing belts are truly endless timing belts, length are available from 2.500m~20.000m.

产品特点

- 高负载
- 宽广的长度范围可供选择
- 同时具有开口同步带的特性

Product Characteristics

- High traction load
- Wide range pitch length to meet the requirement
- All the characteristics of open ended belt

标准型号 / Standard Range

T10 - T20 - AT10- AT20 - L - H - XH -XXH - HTD8M - HTD14M - HTD20M

订购示例 / Order Example

1	2	3
CSHFLEX	50 T10 8600	CUSTOMER-MADE

1. CSHFLEX – Truly endless belt, without joint
2. 50 – Belt width; T10 – Belt type; 8600 – Belt length
3. CUSTOMER-MADE – special manufacture according to customer's requirement

注：可以根据客户需要来样或图纸定做加工。

Customer-made producing and processing against samples or drawings are available.

特殊同步带

Special Timing Belts



CS-01



CS-02



CS-03



CS-04

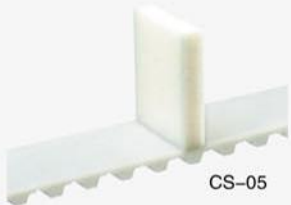

CS-05



CS-06



CS-07



CS-60



CS-61



CS-10



CS-13



CS-15



CS-16



CS-20



CS-21



CS-62



CS-63



CS-26



CS-27



CS-28



CS-08



CS-29



CS-31

特殊同步带

Special Timing Belts



CS-32



CS-33



CS-64



CS-65



CS-35



CS-36



CS-37



CS-38



CS-39

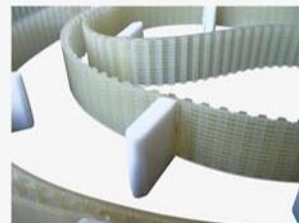

CS-66

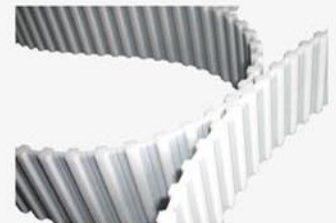

CS-41



CS-42



CS-43



CS-44



CS-45



CS-46



CS-34



CS-22



CS-47



CS-67

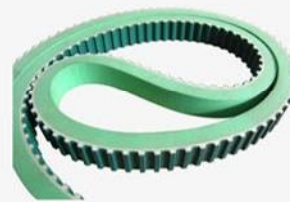

CS-68

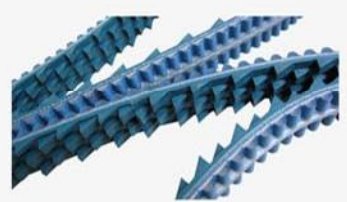

CS-69

绍兴凯一同步带有限公司
Shaoxing CSHBELT Co., Ltd.



地址：浙江省嵊州市经济开发区

Add: Shengzhou Economic Development Zone, Shengzhou city-312400, Zhejiang, China

中国市场

电话：0575-83568111, 83532199

传真：0575-83568222

中文网站：www.cshbelt.cn

OVERSEA MARKET

Tel: +86 575 83706855, 83706866 Fax: +86 575 83035029 <http://www.cshbelt.com> E-mail: sales@cshbelt.com
